



<sup>®</sup>  
**BUILD A BETTER HOME**

## AVOIDING MOISTURE ACCUMULATION IN WALLS

Walls are an integral part of a structure's weather-resistive system. Details in wall design and construction are important in preventing damaging moisture build-up, whether the moisture originates from outside or inside the building.

The Build a Better Home program from APA – *The Engineered Wood Association* is designed to provide builders and homeowners with the construction guidelines they need to protect their homes against damaging moisture infiltration. Key elements in the building envelope are the roof, walls, and foundation.

This publication outlines the two primary sources of moisture in wood wall construction and methods of preventing its accumulation.

FIGURE 1

### CROSS-SECTION OF WINDOW SHOWING INTEGRATION OF STRUCTURE'S WEATHER-RESISTIVE SYSTEM IN A WALL WITH WOOD SIDING

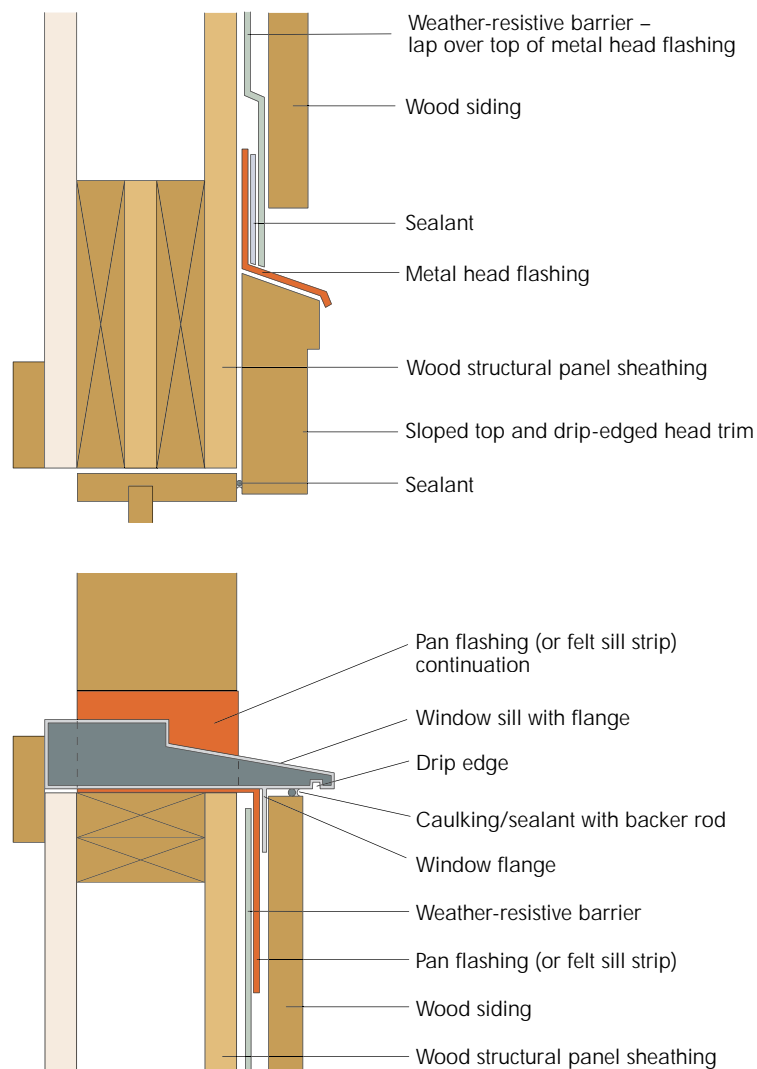

Water can accumulate in walls from two sources: water leaks, and vapor laden air that penetrates the wall to produce condensation. Water from leaks presents the greatest threat of water accumulation in walls. Since water can leak directly into the wall, it can quickly accumulate to levels that will degrade the wood components as well as other products in the wall. Moisture vapor from air penetration and vapor diffusion are important, but represent much smaller amounts of water accumulation.

### HOW WATER LEAKS INTO WOOD WALL CONSTRUCTION

Water leaking through the envelope of a structure is the largest contributor to building damage. Leaks are caused by a number of factors, including:

- Improper or missing flashing
- Improper installation of weather-resistive barriers
- Poorly designed or executed wall intersections and penetrations

Wood structures have the ability to absorb, distribute and dissipate small amounts of water, especially from intermittent sources. The problems arise when there are design or construction errors that allow water into wall cavities at a rate that exceeds the structure's ability to absorb and eliminate the water. Wood construction will perform indefinitely but is subject to failure if exposed to prolonged wetting where the wood moisture content exceeds 19 percent.

FIGURE 2

### FLASHING WINDOW WHEN USING HOUSE WRAP

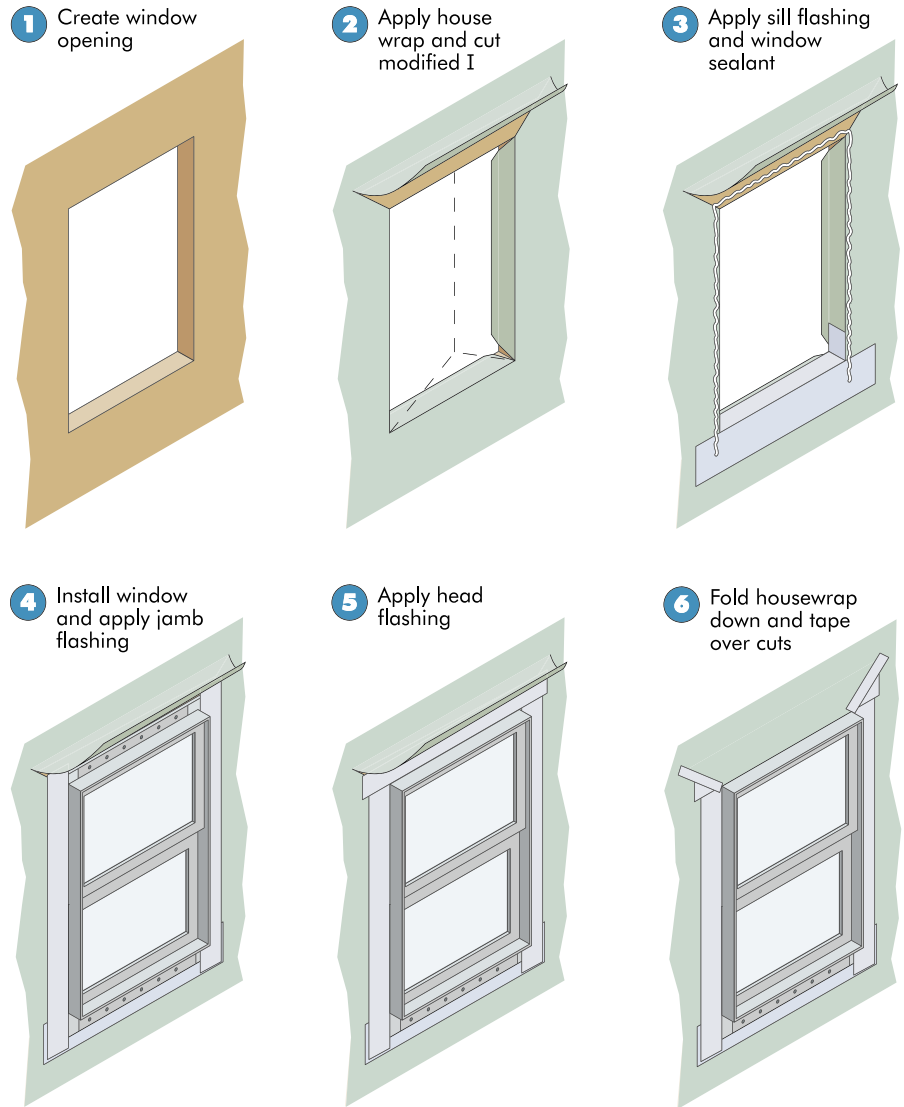

The control of water leaks into walls involves proper design, construction and maintenance. Design features such as roof overhangs can provide moisture protection. Proper construction incorporates products like flashing, weather-resistant barriers, and caulks with the structural and architectural components in such a way that water is deflected or drained down and away from the wall. Proper maintenance of caulks and paint is necessary for long-term moisture performance of walls.

### PREVENTING LEAKS WITH FLASHING

Flashing is used to deflect water and thus prevent leaks around wall intersections, window and door openings, and penetrations. Flashing can be made from galvanized steel, copper, aluminum, lead, vinyl or cut strips of weather-resistant barrier materials. At small wall penetrations, such as exhaust vents, custom flashing is used in lieu of conventional flashing because of the irregular shapes.

Flashing directs water flow down and away from the interior of the structure to the outside of the wall covering. In every example shown here, the weather-resistant barrier laps over the top edge of the flashing. In such a manner, the flashing is part of a whole weather-resistive system that is continuously redirecting water flow down and away from the interior of the structure.

Figures 1 through 14 illustrate examples of typical flashing details for wood-framed walls with various exterior finishes.

FIGURE 3

### FLASHING WINDOW WHEN USING BUILDING PAPER

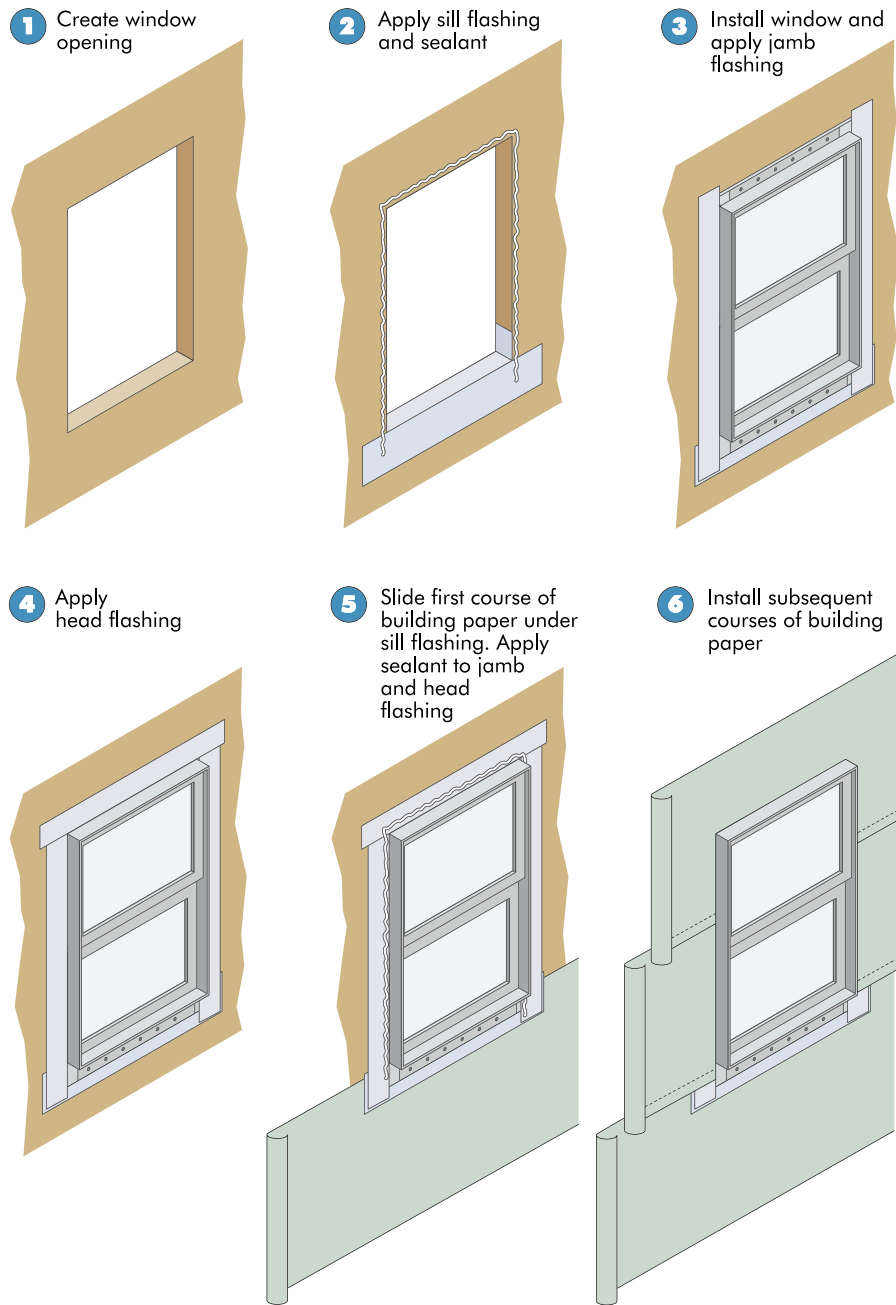

## WEATHER-RESISTIVE BARRIERS

Long-term durability of wood-framed walls relies in part on protecting moisture sensitive wood sheathing with a protective weather- or water-resistive barrier (i.e., building paper), or an approved alternate, such as “house wrap” that also sheds water. *In this publication, all references to weather-/water-resistive barriers and house wrap will be referred to as weather-resistive barriers.*

Weather-resistive barrier materials provide a line of defense for the building envelope against the intrusion of water. The materials and labor costs associated with these products provide inexpensive protection for structural components and reduce the risk of moisture accumulation and damage to moisture sensitive materi-

als. The barriers must be installed properly, however, to prevent water leaks into the wall cavity. Proper installation at corners and intersections and incorporation of flashing are particularly important. The basic principle behind weather-resistive barrier materials is to provide a continuous drainage plane that sheds moisture down and away from the plane of the structural wall surface. This is accomplished by overlapping successive layers of weather-resistive barrier behind the exterior finish and over the structural sheathing. In conjunction with properly applied flashing, weather-resistive barriers direct leakage away from the wood structural panel sheathing. This principle also extends to wall penetrations, such as windows and

doors, plumbing hose bibs, electrical boxes, wall-mounted air conditioners and vents for appliances; and at junctures with horizontal surfaces such as exterior decks and cantilevered balconies, and sloping roof-to-wall surfaces. It is especially important in these cases to insure that water leaks are not directed down the sheathing onto structural elements below, or into the wall cavity.

Figures 1 through 14 illustrate how the weather-resistive barrier materials and flashing work together to channel any water running down the inside face of the barrier over the flashing and outside of the envelope.

FIGURE 4

### SILL FLASHING AT SLIDING GLASS DOOR

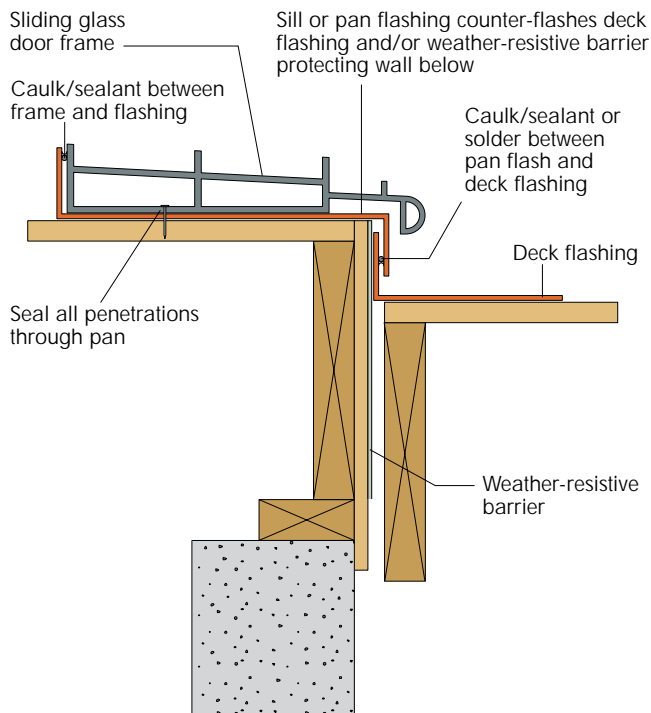

FIGURE 5

### PROPER INSTALLATION OF Z-FLASHING IN A SINGLE WALL SYSTEM WITH APA RATED SIDING

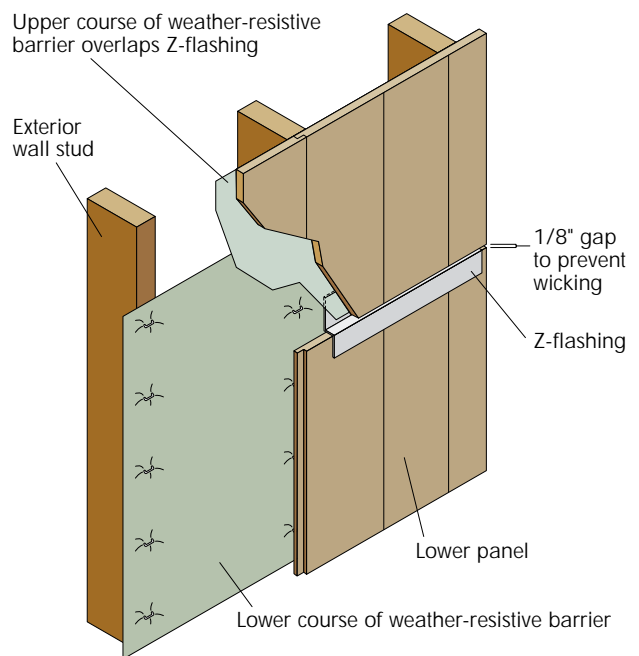

FIGURE 6

**CROSS SECTION OF WINDOW SHOWING INTEGRATION OF STRUCTURE'S WEATHER-RESISTIVE SYSTEM IN A WALL WITH BRICK VENEER**

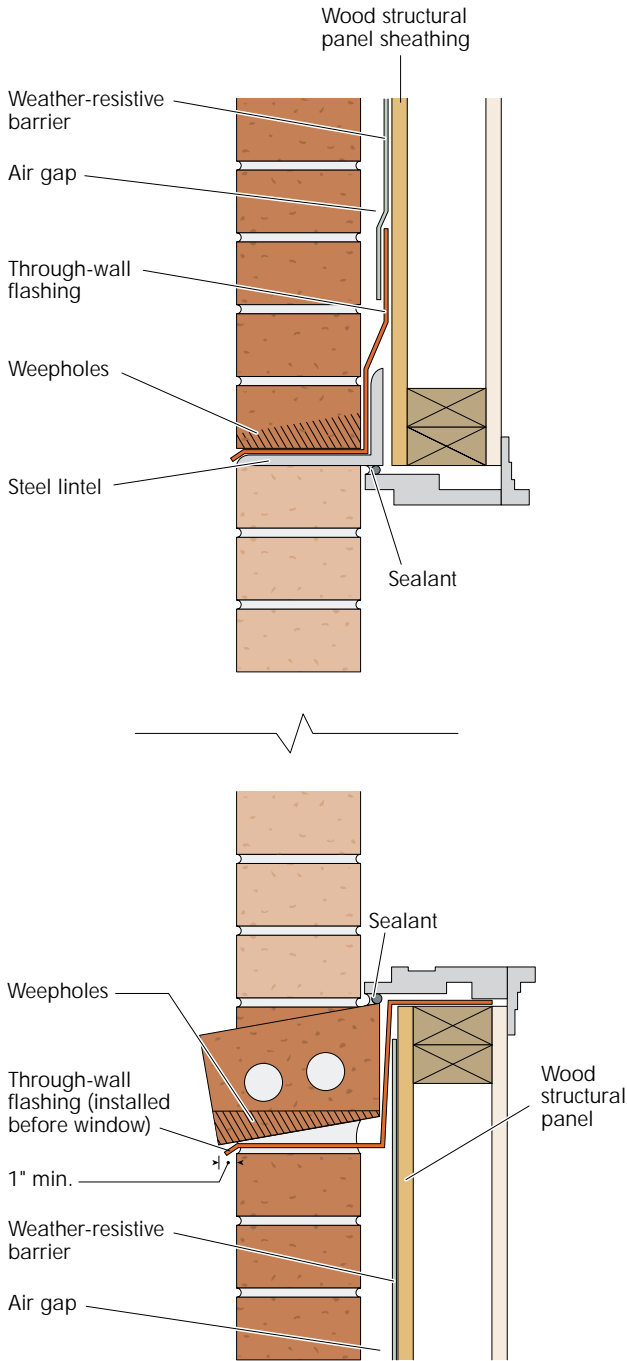

FIGURE 7

**CROSS SECTION OF WINDOW SHOWING INTEGRATION OF STRUCTURE'S WEATHER-RESISTIVE SYSTEM IN A WALL WITH PORTLAND CEMENT STUCCO EXTERIOR WALL COVERING**

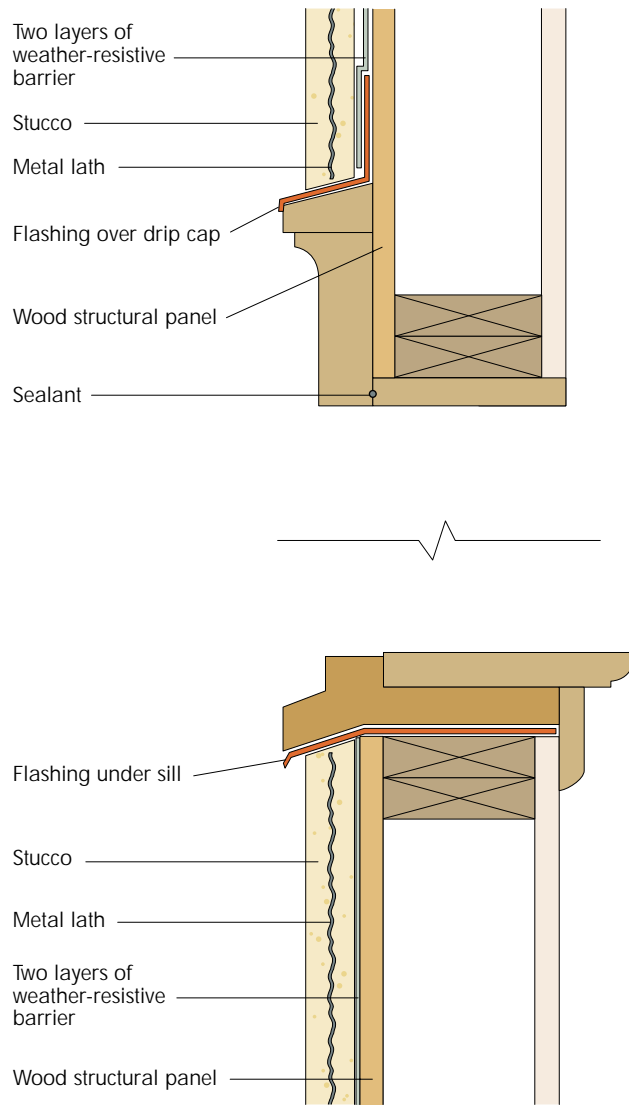

FIGURE 8

**FLASHING AND WEATHER-RESISTIVE BARRIER INSTALLATION AT BRICK LEDGE**

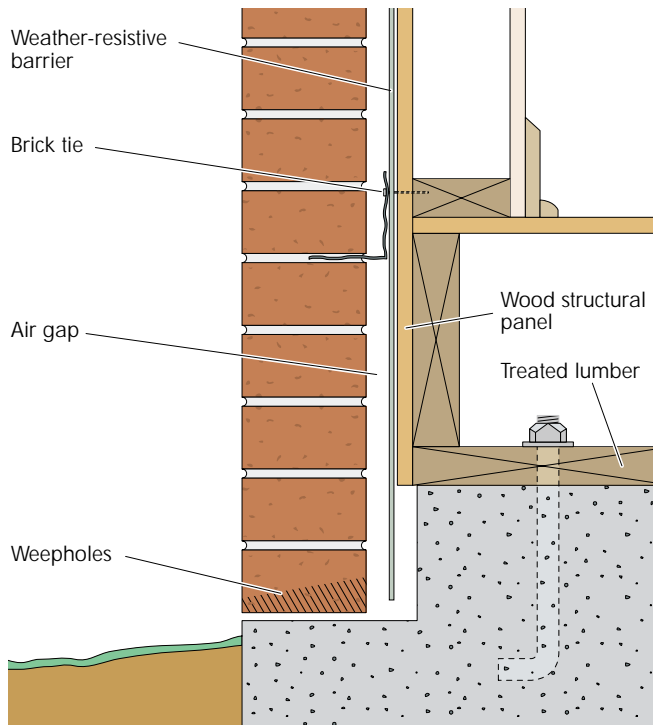
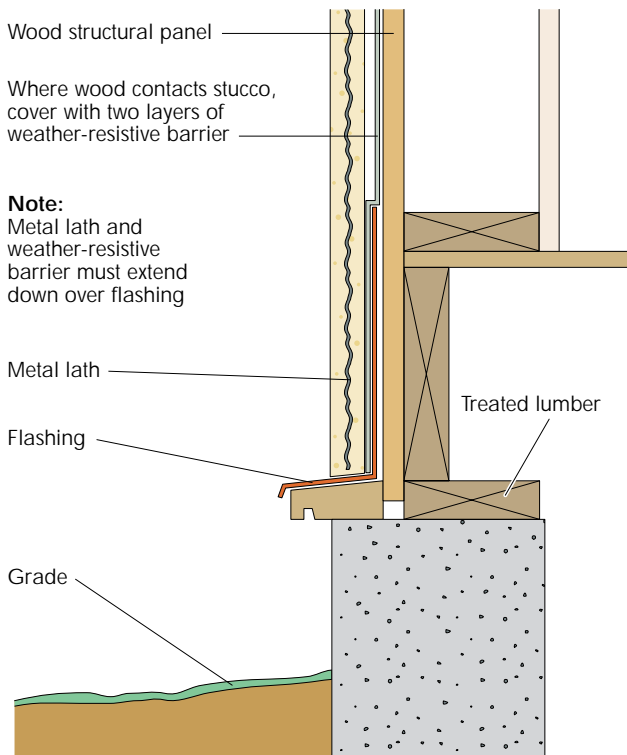

FIGURE 9

**FLASHING INSTALLATION AT TERMINATION OF PORTLAND CEMENT STUCCO EXTERIOR WALL COVERING**



**Wall Intersections and Penetrations**

Unique construction detailing situations call for special attention, including:

- Deck to wall intersections
- Wall to roof intersections
- Gutter to roof or wall intersections
- Skylight installation

Figures 10 and 11 illustrate typical wall intersection details. Figure 12 shows a very common wall penetration detail. Figure 13 is an example of the detailing required at the intersection of an outside deck and an exterior wall. Figure 14 shows the flashing and use of building paper around a door opening.

FIGURE 10

**FLASHING INSTALLATION AT BRICK VENEER-TO-ROOF INTERSECTION**

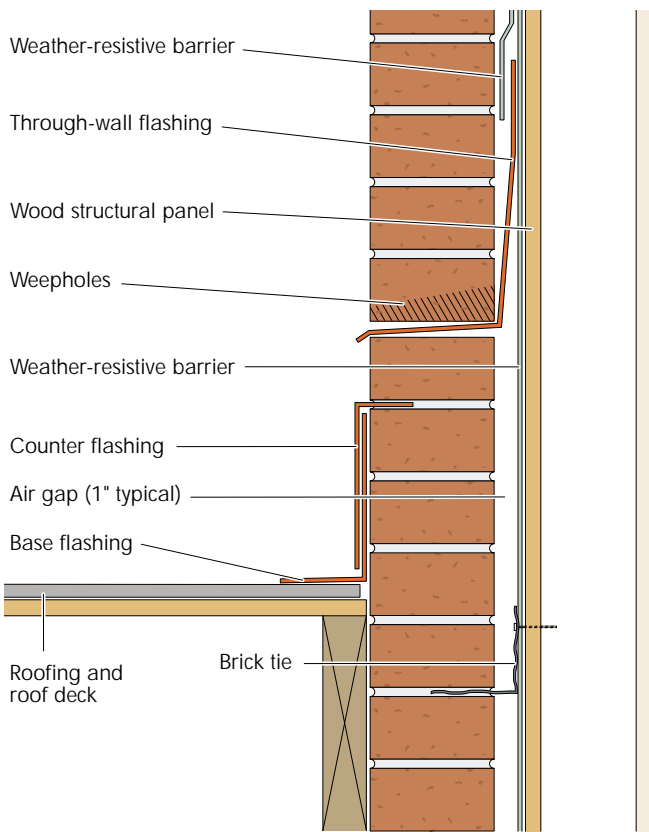

FIGURE 11

**FLASHING INSTALLATION AT PORTLAND CEMENT STUCCO-TO-ROOF INTERSECTION**

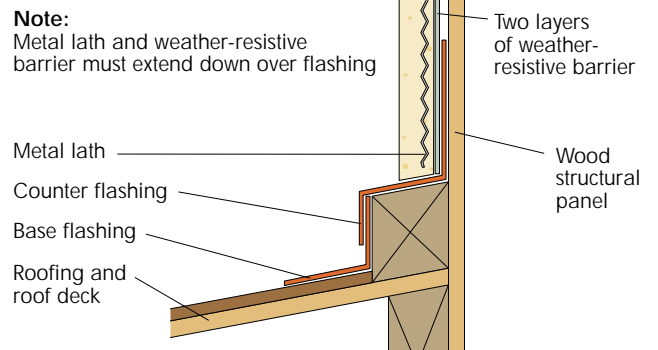

FIGURE 12

**INTEGRATION OF STRUCTURE'S WEATHER-RESISTIVE SYSTEM AT A TYPICAL WALL PENETRATION**

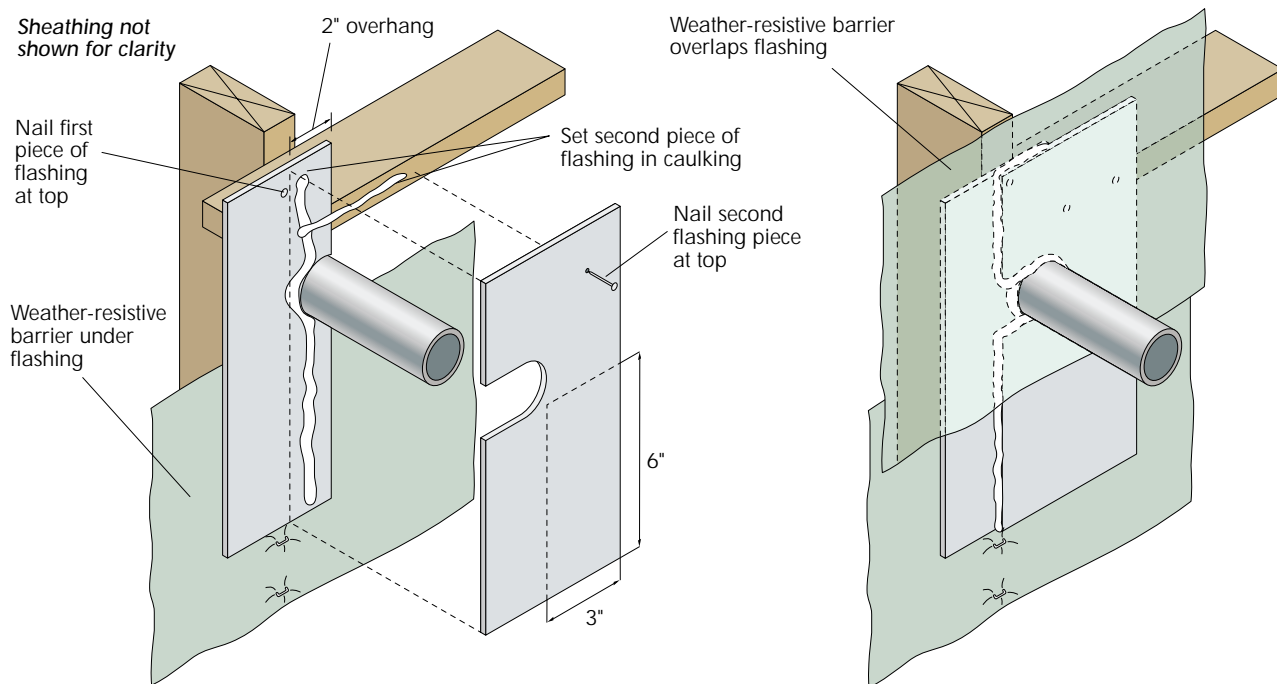

FIGURE 13

**WEATHER-RESISTIVE SYSTEM AT AN EXTERIOR DECK**

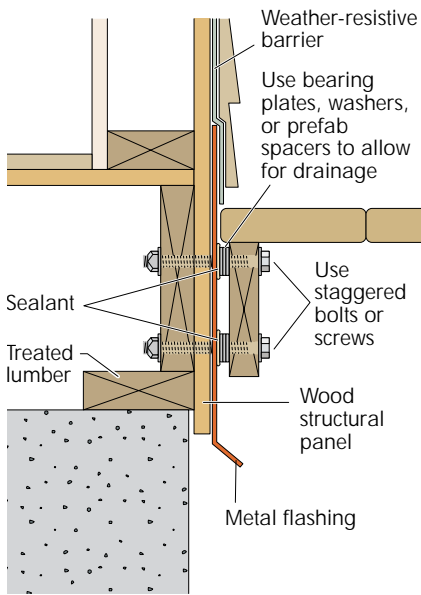
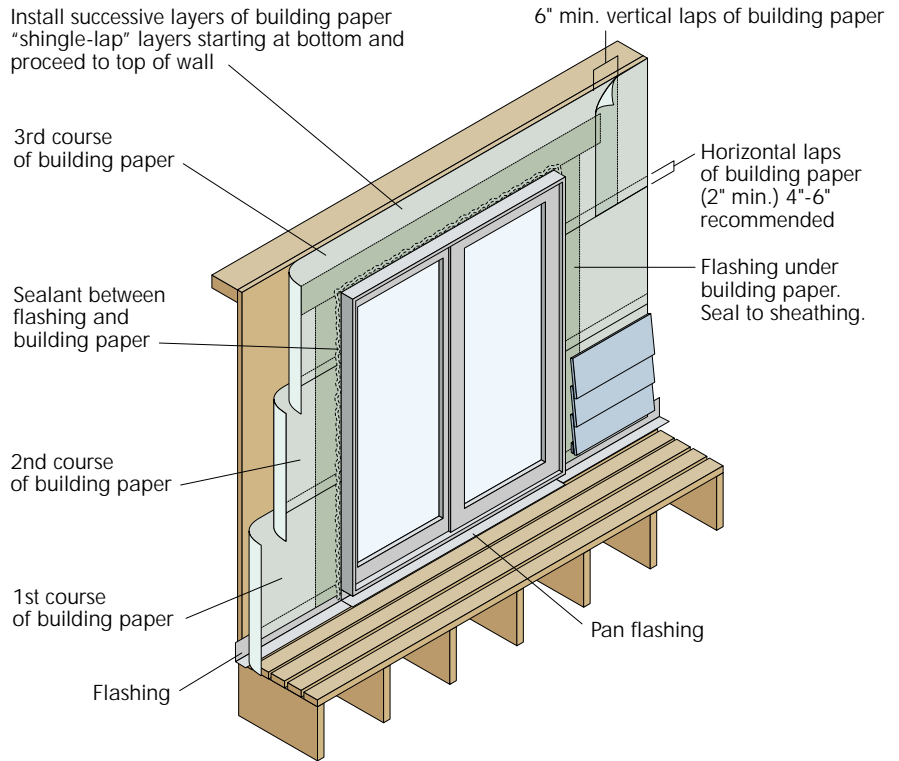

FIGURE 14

**PROPER INSTALLATION OF BUILDING PAPER – SHOWN AROUND A DOOR OPENING**



**CAULKING AS A WATERPROOFING COMPONENT**

Elastomeric exterior sealants, known as caulks, are a popular component of the waterproofing system used in modern structures. Used to seal the cracks between individual elements of the building’s exterior finish, caulks help keep wind and water from penetrating the skin of the structure. Caulks are never perfect, even when carefully installed. However, caulks can be used as a secondary or tertiary part of the weather-protective system.

**Caulks are not permanent!** They have a limited lifetime and must be replaced on a periodic basis. As a result, a caulked joint cannot be the sole form of waterproofing at a given location. Intelligent building design, the use of back-up methods of waterproofing such as building paper or “house wrap,” and

proper placement of flashing should always be used in conjunction with caulked joints.

A caulked joint is ineffective if it is not properly applied to a clean surface. A well-caulked joint should maximize the surface area between the caulk and the application surface. It should also have a smaller cross section between the contact surface than it has at the mating surface. Figure 15 illustrates this. A smaller cross section in the middle of the caulked joint allows differential movement within the caulked joint, alleviating concentration at the mating surface between the caulk and the surface to which it is applied. While the caulk is flexible, the joint between the caulk and the mating surface is not. If stress is concentrated at the joint, it will cause premature failure of the joint.

FIGURE 15

**CAULKED JOINT GEOMETRY**

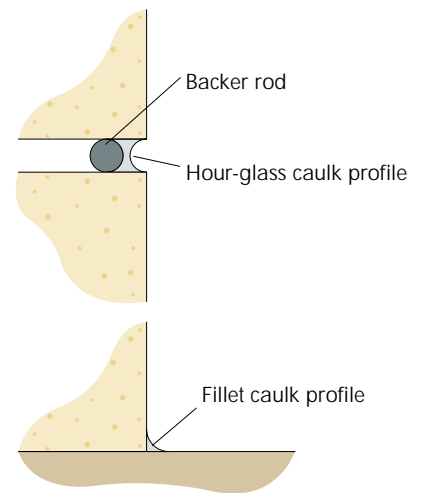



## MOISTURE FROM CONDENSATION

Condensation of vapor is a source of moisture intrusion. Condensation occurs if there is a significant drop in the air's temperature as it passes through an insulated wall such that the air temperature falls below the *dew point*. The dew point is the temperature at which moisture vapor in the air condenses. If it happens to be within the wall cavity, the building materials absorb this moisture, and thus the moisture content of the building materials increases. The moist air can enter from the inside or the outside, depending on the vapor pressure differential across the wall. In a hot, moist climate with air-conditioned buildings, there could be infiltration from the outside to the inside. In cold, dry climates, the inside air leaking out could cause the problem.

## Air Infiltration in Wood Wall Construction

Condensation in wall systems may be caused by air infiltration. Even relatively small differential pressures across a given wall can cause a large volume of moisture-laden air to leak into or out of a structure, thereby increasing the risk of condensation within the wall.

## Air Infiltration Barriers

Differential air pressures existing across the wall cause air infiltration. This differential air pressure can be caused by an unbalanced ventilation system, the stack effect caused by hot air rising within the structure, the use of unvented heating appliances, or wind. The actual differential pressure does not have to be very large to cause a significant amount of air leakage in one direction or another. If the moisture-laden airflow persists for a significant length of time, the moisture

buildup can cause moisture damage to the structure and degrade the living conditions therein.

An air infiltration barrier such as house wrap retards the flow of moisture-laden air into the wall cavity. Because it does not matter where the airflow is stopped, the air barrier can be placed on the inside or outside surface of the wall. In a cold climate that requires a warm-side vapor retarder, the vapor retarder may act as the air barrier as well, if properly applied and sealed.

FIGURE 16

### PROPER AIR BARRIER INSTALLATION DETAILS TWO-STORY WALL SHOWN (not to scale)

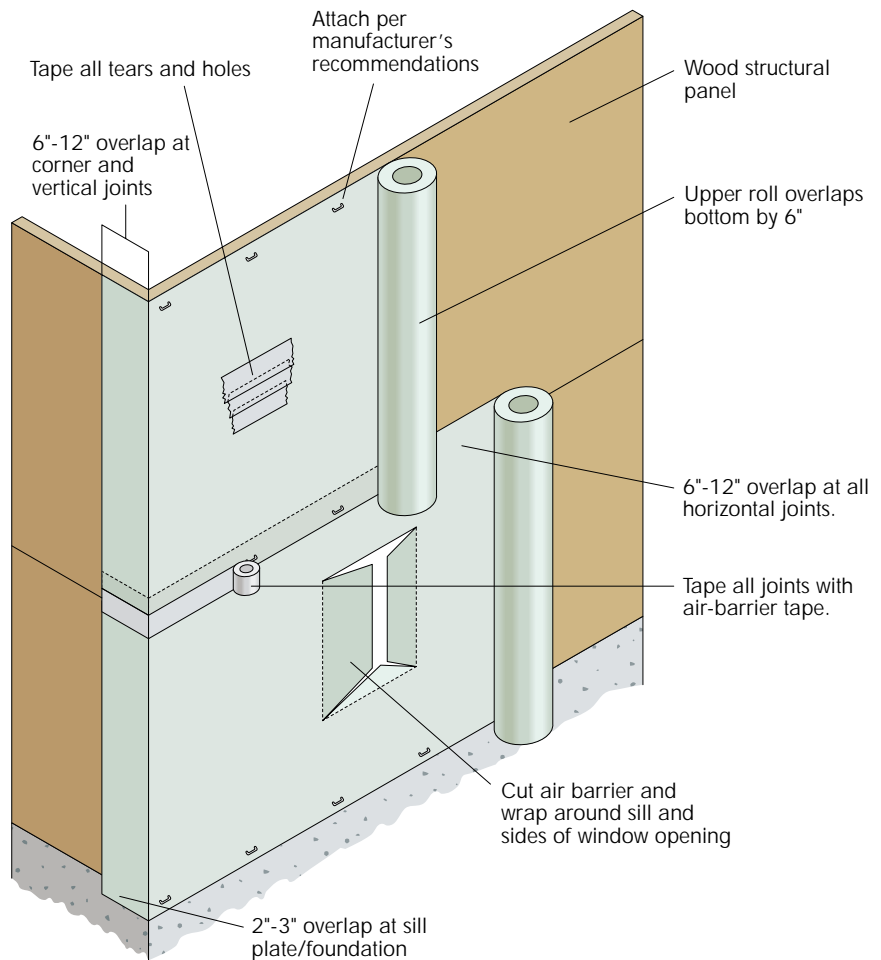

Because the major model building codes allow air infiltration barriers to be used in lieu of building paper for most applications, the use of these products is on the rise. To get the full benefits of an air barrier, it must be sealed as described below to ensure that it is airtight.

Air infiltration barriers are available in rolls up to 9 ft wide, allowing the builder to wrap the barrier all the way around the house during construction. This is the origin of the term “house wrap.” The large size speeds up installation and minimizes the number of seam seals. When the wrap is used as an air barrier, all of the splits, seams, penetrations and damaged areas must be repaired using a special adhesive-backed seam tape. In this respect, an air barrier differs from a vapor retarder.

Figures 16 and 17 show general installation techniques for proper application of an air barrier.

### Vapor Transmission in Wood Wall Construction

Vapor transmission is the molecular passage of water through the components of a building. A differential water vapor pressure across the wall causes this movement. In cold weather, vapor from the interior of the structure can permeate through the interior wall finish and condense on cooler framing and sheathing surfaces in the wall cavity if there are surfaces colder than the dew point temperature. To prevent this, an effective interior (‘warm side’) vapor retarder, installed beneath the interior wall finish, is recommended by codes for most cold climate regions.

The “warm side” vapor retarder in exterior walls may be omitted in regions with moderate temperatures, such as the southern and southeastern United States. In warm, humid regions close to the Gulf of Mexico, and in Hawaii and the Caribbean regions, where air conditioning is prevalent, the vapor retarder should be installed on the exterior side of the wall, behind the sheathing. This will prevent humid air from penetrating into the wall cavity and causing increased condensation on the cooler interior wall surface.

### Selection and Installation of Vapor Retarder

When the warm side is determined to be the inside wall, the vapor retarder can be a kraft paper or foil/kraft paper facing on the wall insulation. The effectiveness of this vapor retarder depends on how carefully the insulation is installed. The most effective installation technique is to cut the insulation batt length slightly oversize so it can be friction-fit to avoid gaps at the top and bottom wall plates. Also, the installation tabs of the insulation facing should be lapped and stapled onto the nailing surface of the studs, instead of the sides of the studs, to “seal” the insulation facing against air and moisture leakage, and to minimize gaps between the insulation and studs.

Alternatively, an effective continuous vapor retarder can be installed by using a separate layer of 4-mil polyethylene sheeting, stapled over the interior side of the wall framing. In this case, unfaced

FIGURE 17

### AIR INSTALLATION DETAILS USING HEADER WRAP

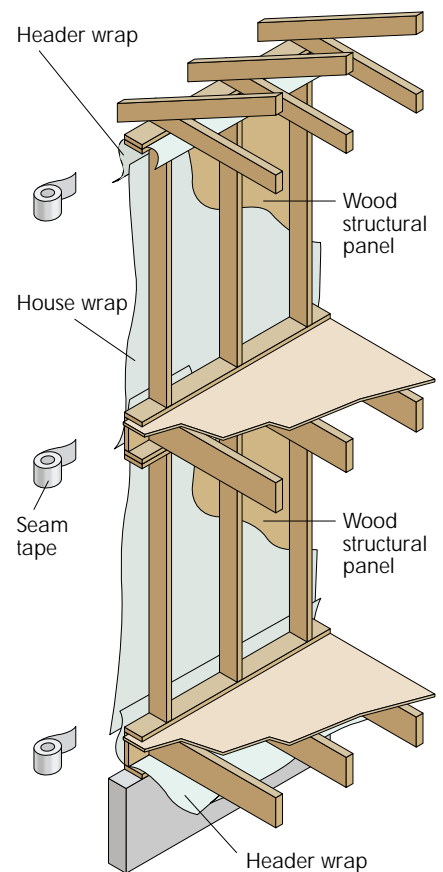

insulation without an integral vapor retarder facing may be used, and friction fit to fill the stud cavities without gaps.

While polyethylene sheeting makes a very good vapor retarder, it is relatively difficult to install. In most cases, the use of polyethylene is not necessary, even in very cold regions. Ordinary interior latex paint applied over drywall can provide sufficient vapor retardant properties.

## INSTALLING RAIN-SCREEN WALLS

The entire exterior finish, weatherproofing, and flashing system in wood construction relies on gravity to keep bulk water out of the building envelope. Wind-driven rain can compromise these safeguards because the water is hitting the wall from a different angle. If wind-driven rain is an infrequent occurrence, the forgiving nature of wood construction can often account for the occasional influx of water into the building system. The moisture will be removed through capillary suction and the entire building frame will dry.

In areas where wind-driven rain is frequent, the amount of water driven into the wall system could be more damaging. In these cases, double-wall construction – also known as a rain-screen wall – is often used. Double-wall construction creates an air space between the exterior finish system and the weather-resistive system. This separation is made with the use of pressure-treated lumber spacers that are installed vertically and carefully detailed around openings and penetrations to allow drainage of any water that makes it through the exterior finish. This space – 3/4 to 1 inch – is open at the bottom to promote drainage and closed at the top to allow the air space to equalize with the exterior air pressure. The opening at the bottom has a pest screen. This system is often used with an interior air barrier to allow the air pressure in the interior of the wall to equalize with that in the air space behind the cladding. This will eliminate the driving force that causes water to leak into the wall.

FIGURE 18  
RAIN-SCREEN WALL DETAILS

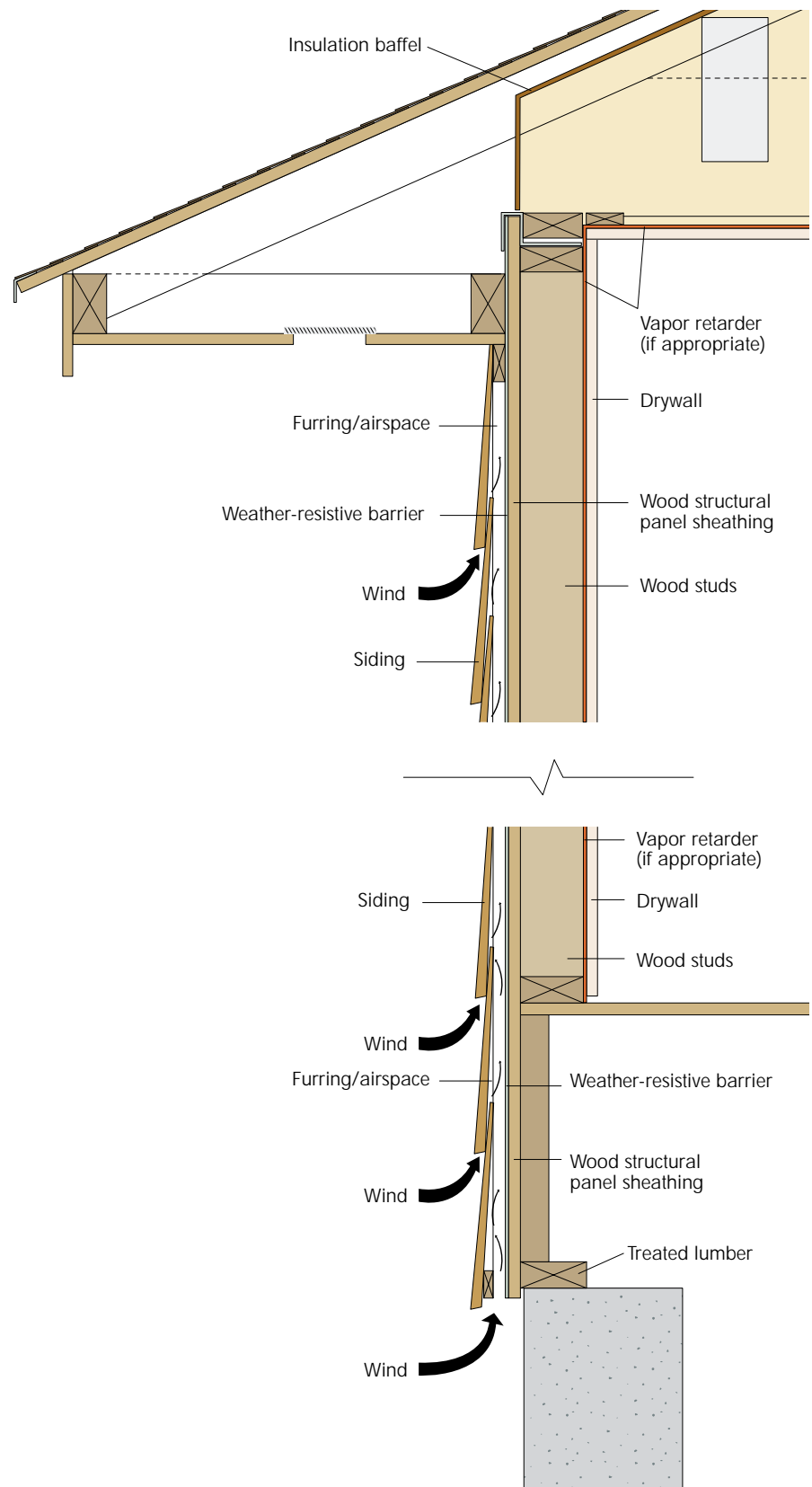

## ADDITIONAL INFORMATION

### About APA – The Engineered Wood Association

APA – The Engineered Wood Association is a nonprofit trade association whose member mills produce approximately 70 percent of the structural wood panel products manufactured in North America.

The Association's trademark appears only on products manufactured by member mills and is the manufacturer's assurance that the product conforms to the standard shown on the trademark. That standard may be an APA performance standard, the Voluntary Product Standard PS 1-95 for Construction and Industrial Plywood, or Voluntary Product Standard PS 2-92, *Performance Standards for Wood-Based Structural-Use Panels*. Panel quality of all APA trademarked products is subject to verification through an APA audit.

APA's services go far beyond quality testing and inspection. Research and promotion programs play important roles in developing and improving panel and engineered wood systems, and in helping users and specifiers better understand and apply products.

For additional information on wood construction systems, contact:

APA – The Engineered Wood Association,  
P.O. Box 11700, Tacoma, Washington  
98411-0700.

### More Information Online

Visit APA's web site at [apawood.org](http://apawood.org) for more information on engineered wood products, wood design and construction, and technical issues and answers.

Online publication ordering is also available through the web site.

We have field representatives in most major U.S. cities and in Canada who can help answer questions involving APA trademarked products. For additional assistance in specifying engineered wood products, contact us:

### APA – THE ENGINEERED WOOD ASSOCIATION HEADQUARTERS

7011 So. 19th St. • P.O. Box 11700  
Tacoma, Washington 98411-0700  
(253) 565-6600 • Fax: (253) 565-7265



[www.apawood.org](http://www.apawood.org)

### PRODUCT SUPPORT HELP DESK

(253) 620-7400  
E-mail Address: [help@apawood.org](mailto:help@apawood.org)

(International Offices:  
Bournemouth, United Kingdom;  
Mexico City, Mexico; Tokyo, Japan.)

*The recommendations in this publication are based on a review of credible sources. APA – The Engineered Wood Association maintains a continuing program of laboratory testing, product research and comprehensive field experience on engineered wood products. However, because the Association has no control over quality of workmanship, the conditions under which engineered wood products are used, or the quality of other associated products used in construction or their interaction, it cannot accept responsibility for performance or designs as actually constructed. Because requirements vary geographically, consult your local architect, engineer or design professional to assure compliance with code, construction, and performance requirements.*

Form No. A530A  
Revised October 2002/0100

